

SPECIFICATIONS

CONTACT RATING: Dependent upon contact material See Page 120.

MECHANICAL LIFE: 50,000 make-and-break cycles.

CONTACT RESISTANCE: 20 mΩ max. initial @ 2-4VDC
100mA for both silver and gold plated contacts.

INSULATION RESISTANCE: 1,000 MΩ min.

DIELECTRIC STRENGTH: 1,000 Vrms min. @sea level.

OPERATING TEMPERATURE: -30°C to 85°C.

MATERIALS

CASE: Diallyl phthalate(DAP) (UL94V-0).

PLUNGER: Nylon 6/6,black.

BUSHING: Brass or zinc,nickel plated.

HOUSING: Stainless Steel.

SWITCH SUPPORT: Brass.tin plated.

CONTACT/TERMINAL: Copper alloy or Brass, with silver or gold plated.(See Page 120)



8M Pushbutton Switches



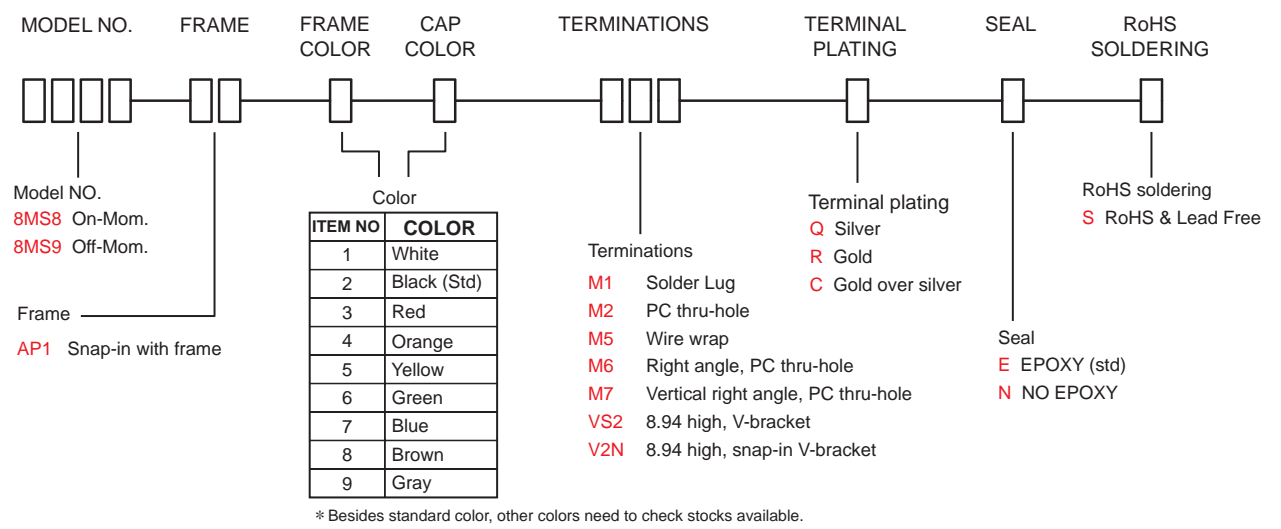
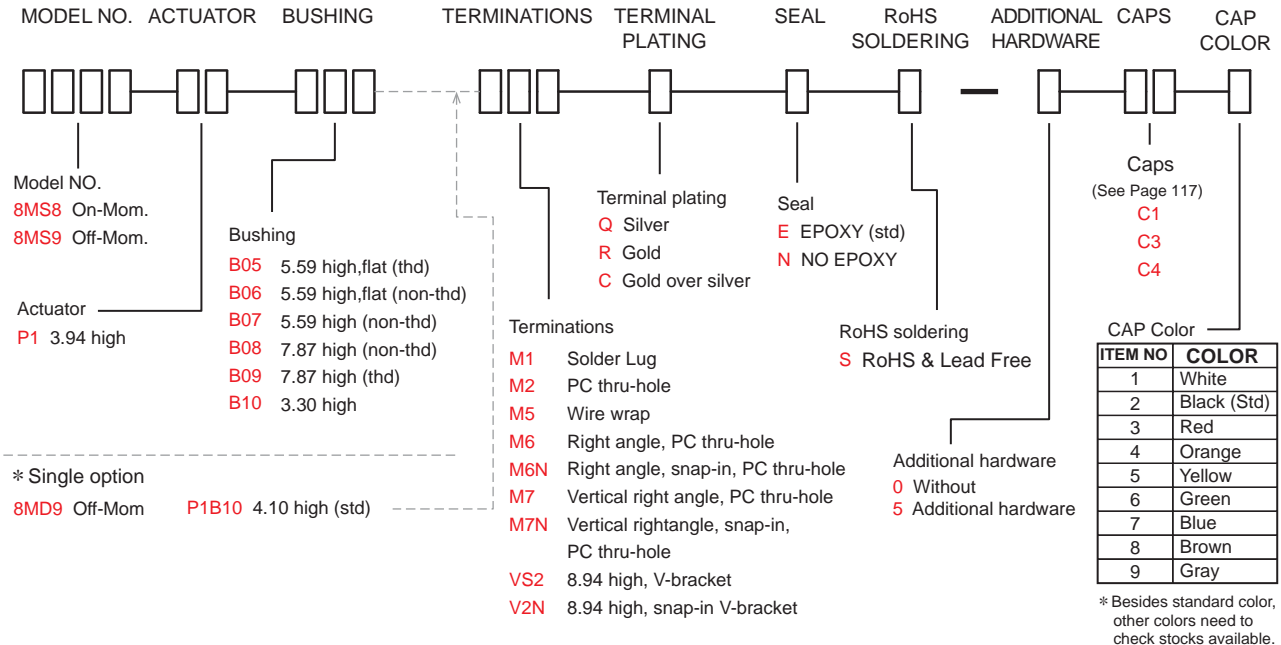



HOW TO ORDER



8M Series

Sub-Miniature Pushbutton Switches

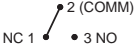
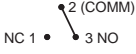
SWITCH FUNCTION

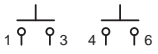
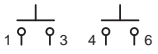
| NO. POLES | UL/CSA MODEL NO. | MODEL NO. | SWITCH FUNCTION | | CONNECTED TERMINALS / SCHEMATIC | |
|-----------|------------------|-----------|---|---|---|--|
| | | | POS.1 | POS.2 | POS.1 | POS.2 |
| | | |  |  |  |  |
| SP | Q2818 | 8MS8 | ON | MOM | 2-1  | 2-3  |
| | Q2819 | 8MS9 | OFF | MOM | OPEN  | 1-3  |
| DP | Q2829 | 8MD9 | OFF | MOM | OPEN  | 1-3,4-6  |

MOM=MOMENTARY

POLE OPTIONS

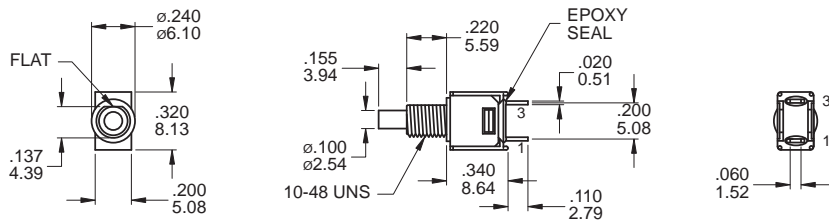

SPST

Part No. Shown : 8MS9P1B05M1QE

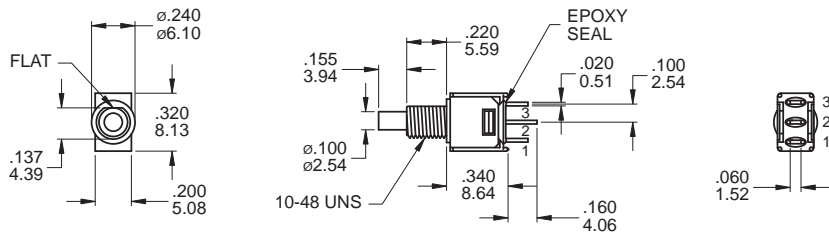

SPDT

Part No. Shown : 8MS8P1B05M1QE

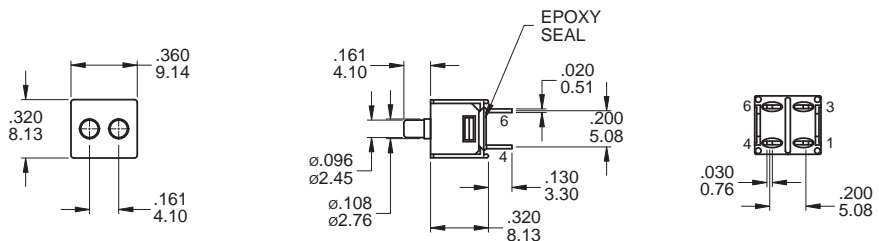

DPST

Part No. Shown : 8MD9P1B10M2RE

BUSHING OPTIONS

B05 THD

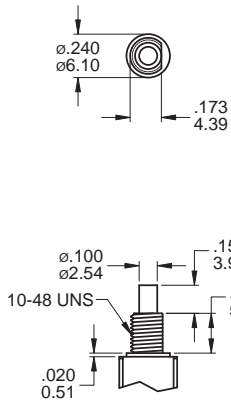

B06 NON-THD

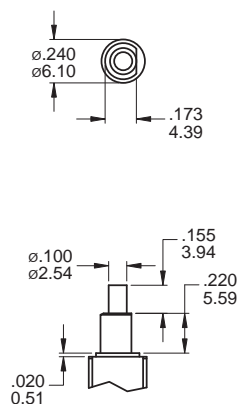

B07 NON-THD

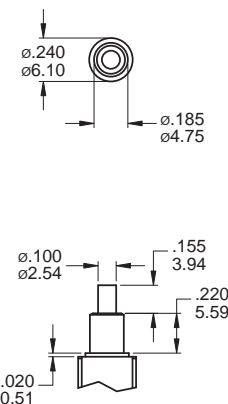

**B08 NON-THD
B09 THD**

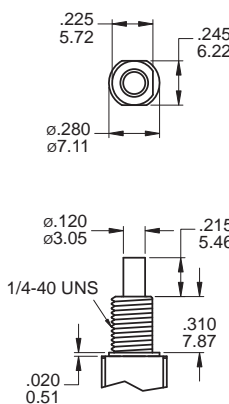

B10

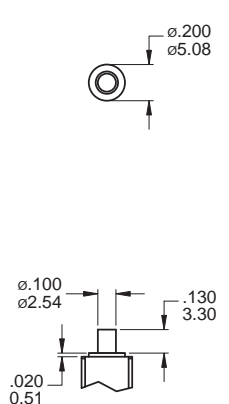

TERMINATION OPTIONS

M1 Solder lug

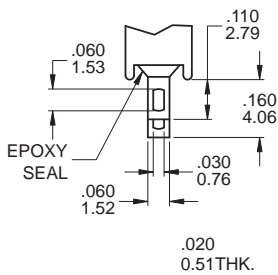

M2 PC Thru-hole

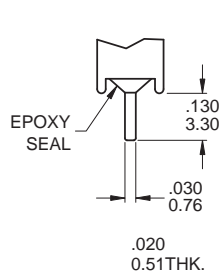

M5 Wire Wrap

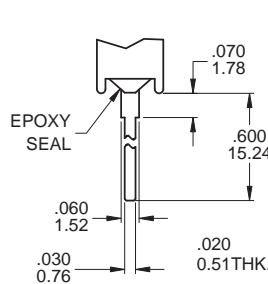

OTHER TERMINATION OPTIONS

- M6** Right angle P.C. Mount
- M6N** Right angle P.C. Mount with snap-in bracket
- M7** Right angle P.C. Mount
- M7N** Right angle P.C. Mount with snap-in bracket
- VS2** Right angle P.C. Mount
- V2N** Vertical bracket P.C. Mount with snap-in bracket

M6

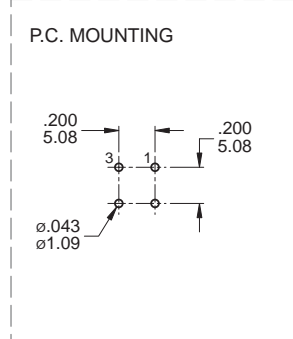
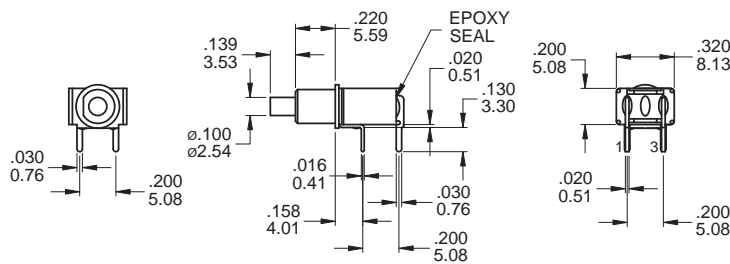

SPST

Part No. Shown : 8MS9P1B06M6RE

M6

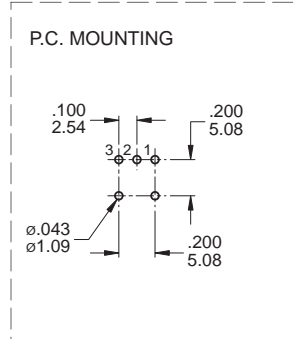
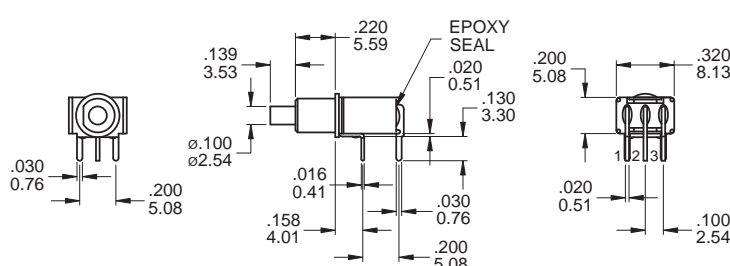

SPDT

Part No. Shown : 8MS8P1B06M6QE

8M Pushbutton Switches

8M Series

Sub-Miniature Pushbutton Switches

M6

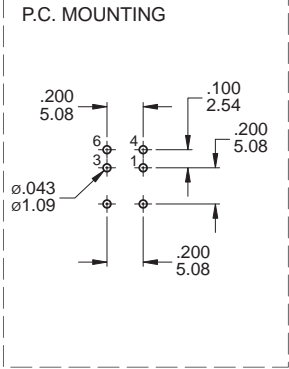
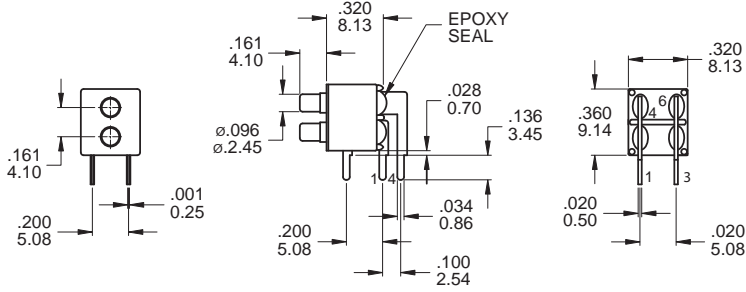

DPST

Part No. Shown : 8MD9P1B10M6RE

M7

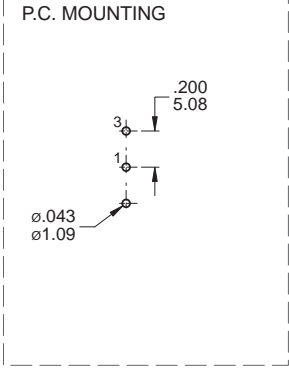
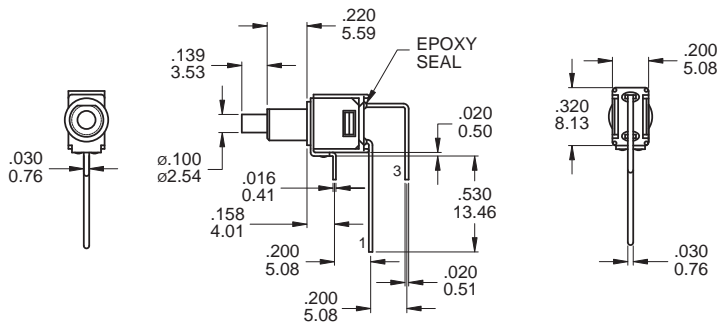

SPST

Part No. Shown : 8MS9P1B06M7QE

M7

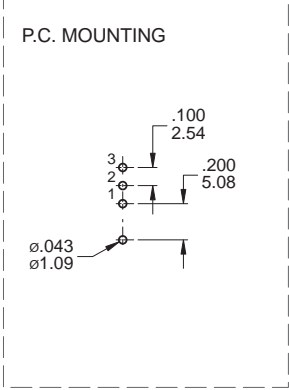
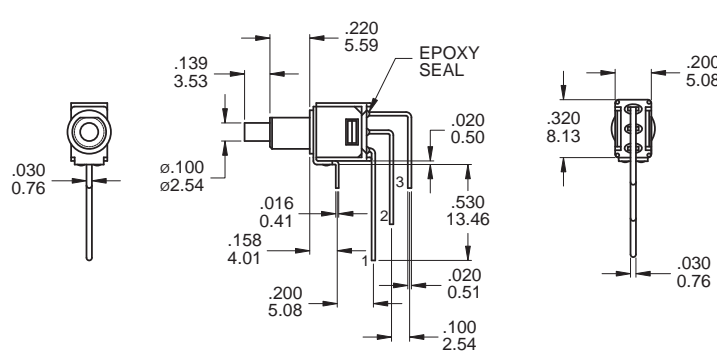

SPDT

Part No. Shown : 8MS8P1B06M7QE

VS2

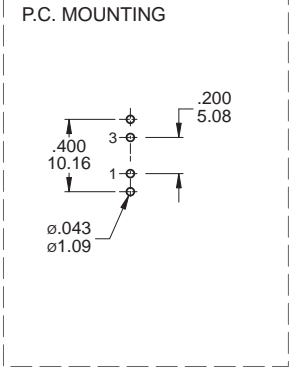
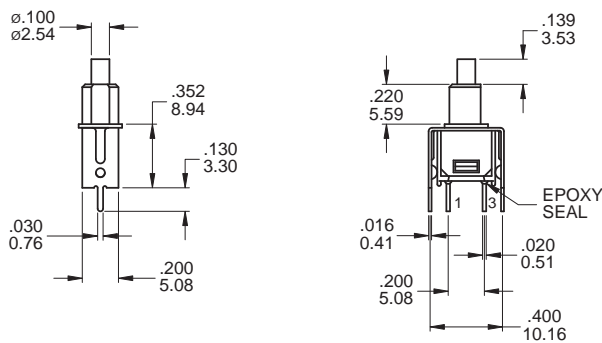

SPST

Part No. Shown : 8MS9P1B06VS2QE

8M Pushbutton Switches

VS2

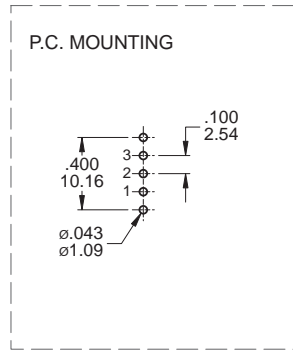
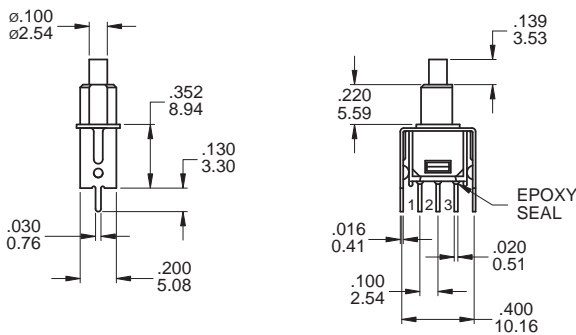

SPDT

Part No. Shown : 8MS8P1B06VS2QE

AP1

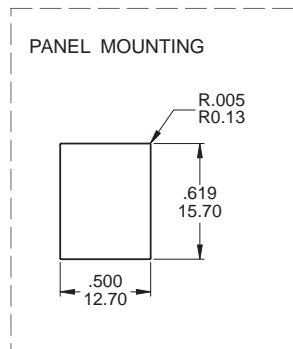
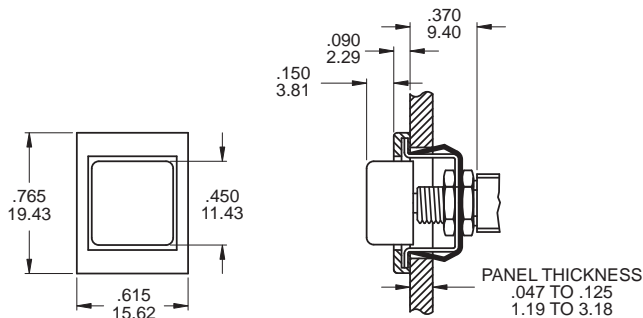

SPST

Part No. Shown : 8MS9AP122M1QE

SNAP-IN TERMINATION OPTIONS

M6N

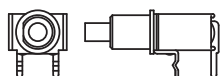

M7N

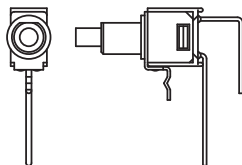

V2N

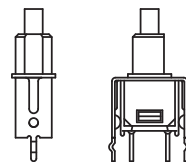

CAP OPTIONS

C1 For 8M Series ONLY

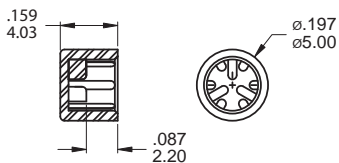

C2 For 8A,8B Series ONLY

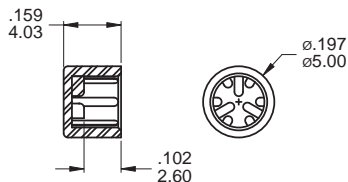

C3 For 8M Series B8,B9 Bushing ONLY

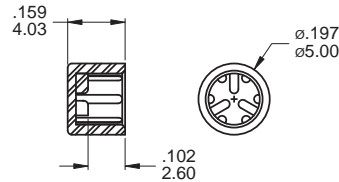

C4 For 8M Series ONLY

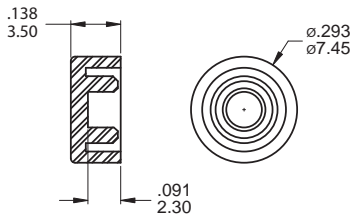

C5 For 8A,8B Series ONLY

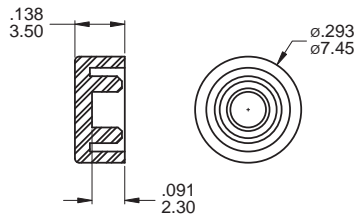

Cap Standard Color : White, Black, Red, Green



8M Pushbutton Switches