

X2-R9(X2-R19) Series

Rocker Switches



SPECIFICATION

Electrical Rating : 12A 125VAC 6A 250VAC (UL)
 4(1)A 250VAC (VDE)
 16A 250VAC/21A 125VAC(UL)
 16(6)A 250VAC(VDE) R91,R9D

Mechanical life: Over 30000 cycles
 Electrical life: Over 10000 cycles
 Contact resistance: <20mΩ
 Insulation resistance: >1000MΩ
 High voltage resistance: >1500VAC 1 min.
 Ambient temperature: Terminal side -20 to +85°C
 Actuating side- 20 to +55°C
 Atmospheric humidity: Max.85%
 Actuating force: 4 to 8N(depends on different switch function)
 Flammability: UL94V-2
 Storage temperature: -30 to +80°C Max
 Temperature rise at the terminal: Max 30°C (UL1054)
 Solder ability of terminal: Max 350°C 3s

MATERIALS

Housing: PA 66
 Rocker: PC & PA66
 Contact: Silver alloy
 Terminal: Brass silver plated
 Lamp: Neon lamp, Tungsten lamp, LED
 Movable arm: Beryllium copper



HOW TO ORDER

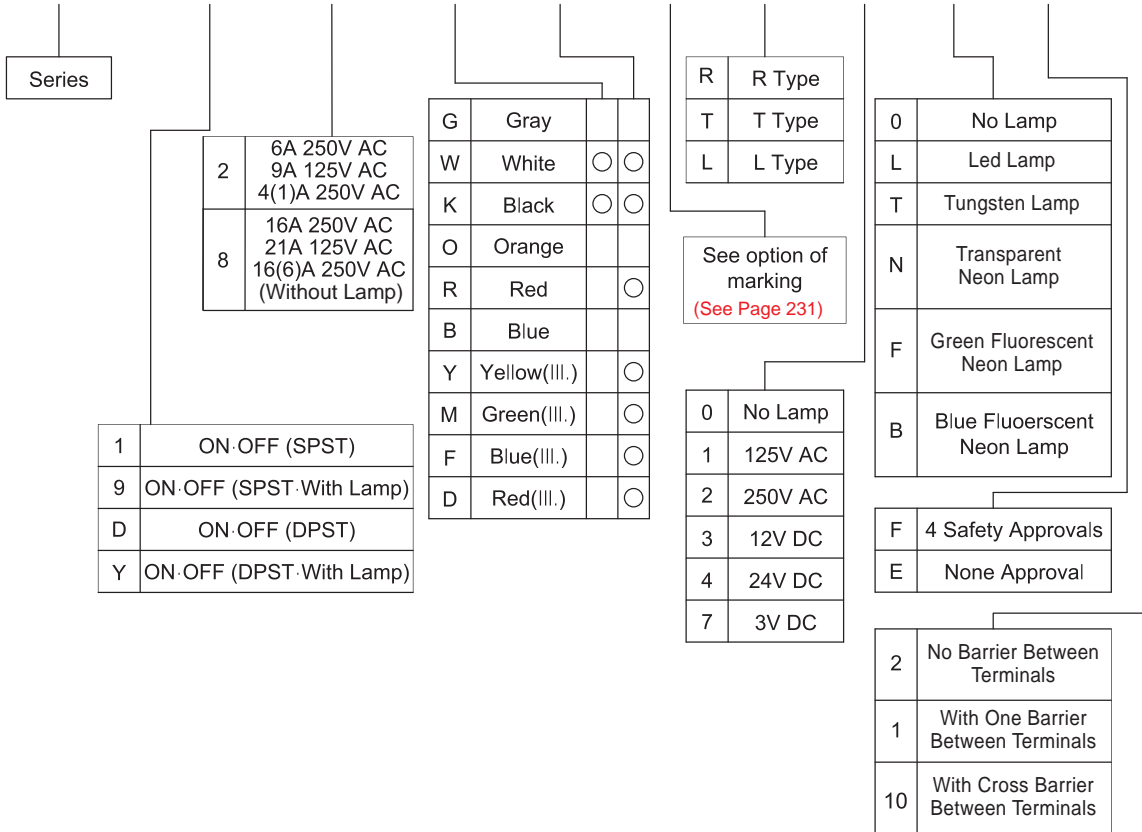

X2-R9 1 2 K K E T 0 0 F 1

Series Switch Function Rating Housing Color Actuator Color Marking Terminal Lamp Voltage Lamp Type Safety Approval



X2-R9(X2-R19) Rocker Switches

OPTIONS OF SWITCH FUNCTION / DIMENSION

Item Number	Poles & Throws	Rocker Position		
				
X2-R91	SPST	ON	NONE	OFF
X2-R99	SPST (WITH LAMP)	ON	NONE	OFF
X2-R9D	DPST	ON	NONE	OFF
X2-R9Y	DPST (WITH LAMP)	ON	NONE	OFF
X2-R9I	Indicator			
X2-R9B	The block sealed on the panel			

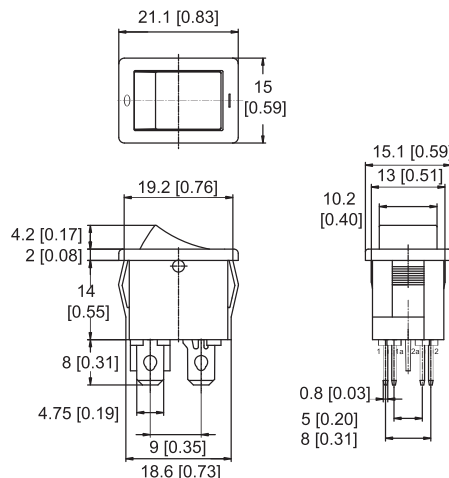

PANEL CUT OUT

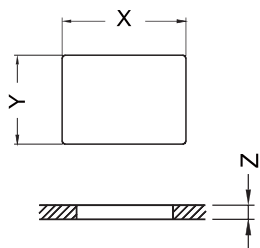

Z	Y	X
0.7~1.25	12.8~12.9	19.2~19.3
1.25~2.0	12.8~12.9	19.3~19.4
2.0~3.0	12.8~12.9	19.5~19.6

CIRCUITS FOR SWITCH WITH LAMP

For circuit of 250VAC, 125VAC with neon lamp

For circuit of 24 VDC, 12 VDC, 6 VDC, 3 VDC with lamp

For circuit of 48 with LED

CIRCUIT FOR R99

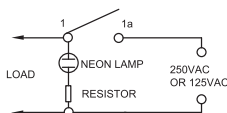

CIRCUIT FOR R9Y

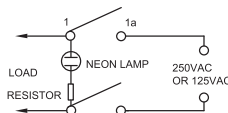

CIRCUIT FOR 48VDC with LED

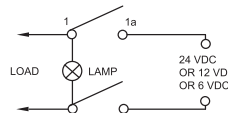
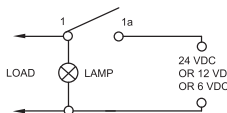
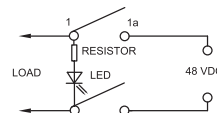

TERMINAL TYPE

T Type

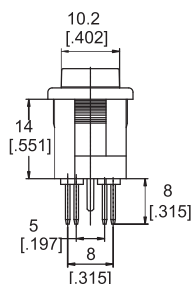

Quick Connect Tab

R Type

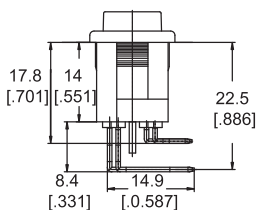

Right Angle PC Through Hole Terminal

L Type

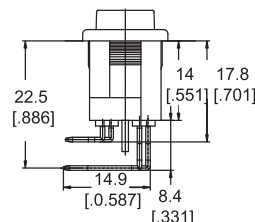

Left Angle PC Through Hole Terminal